



Features

- ◇ For IF SAW filter
- ◇ High attenuation
- ◇ Single-ended operation
- ◇ Dual In-line Package
- ◇ RoHS compliant (2002/95/EC), Pb-free

Specifications

Parameter	Unit	Minimum	Typical	Maximum
Center Frequency	MHz	139.7	140	140.3
Insertion Loss	dB	-	25.8	28
1 dB Bandwidth	MHz	45	46.29	-
3 dB Bandwidth	MHz	48	48.77	-
40 dB Bandwidth	MHz	-	58.35	60
50 dB Bandwidth	MHz	-	59.27	62
Passband Variation	dB	-	0.6	1
Group delay variation(f0±23MHz)	nesc	-	12	30
Phase Linearity(f0±23MHz)	deg	-	4	8.5
Absolute Delay	usec	-	0.98	-
Ultimate Rejection	dB	50	54	-
Material Temperature coefficient	KHz/°C	-11.48		
Substrate Material	-	128LN		
Ambient Temperature	°C	25		
Operating Temperature Range	°C	-40	-	+85
Storage Temperature Range	°C	-45	-	+105
DC Voltage	V	0		
Input Power	dBm	-	-	10
ESD Class	-	1A		
Package Size	DIP2212 (22.2x12.8x4.7mm3)			

Notes:

1. All specifications are based on the test circuit shown;
2. In production, all specifications are measured by Agilent Network analyzer and full 2 port calibration at room temperature;
3. Electrical margin has been built into the design to account for the variations due to temperature drift and manufacturing tolerances;
4. This is the optimum impedance in order to achieve the performance show.

	SIPAT Co., Ltd. (CETC No.26 Research Institute) #14 Nanping Huayuan Road, Chongqing, China, 400060	Part Number	LBN14005	
		Rev. Date	2008-12-24	
		Ver.	1.1	Page

Matching Configuration



L1=82nH L2=18nH
Source/Load Impedance=50 ohm

Notes - Component values may change depending on board layout.

Package Dimension

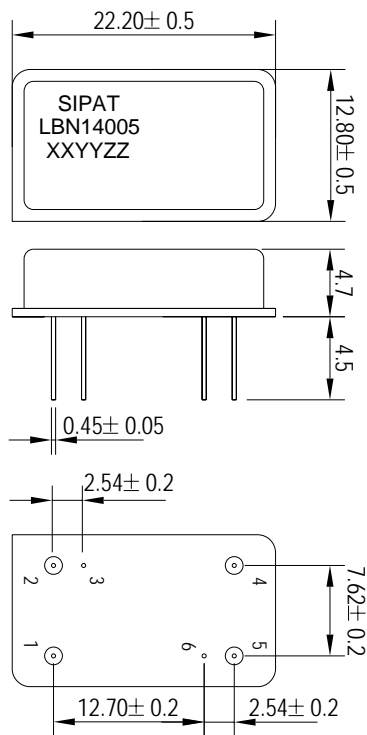

Pad Configuration:

Input 1
Output 5
Ground All Others

Marking Configuration:

- 1) SIPAT: Manufacturer Name
- 2) LBN14005: Part Number
- 3) XXYY: Date(Year/month)
- 4) ZZ: Identified Code

Package: DIP2212

Unit: mm



SIPAT Co., Ltd.
(CETC No.26 Research Institute)
#14 Nanping Huayuan Road,
Chongqing, China, 400060

Part Number	LBN14005	
Rev. Date	2008-12-24	
Ver.	1.1	Page 2/3



Typical Performance

Frequency Respond

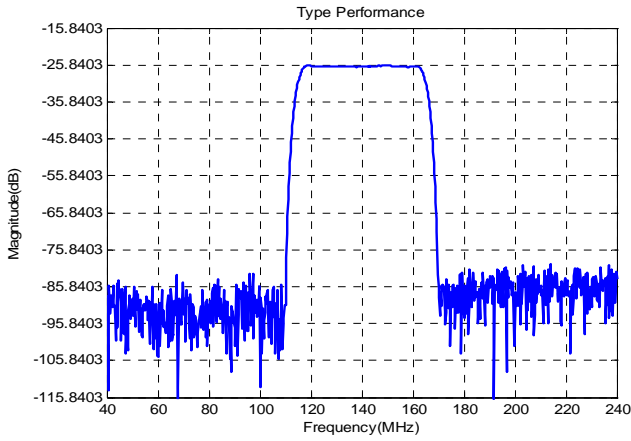

Horizontal: 20MHz/Div Vertical: 10dB/Div

Passband Respond

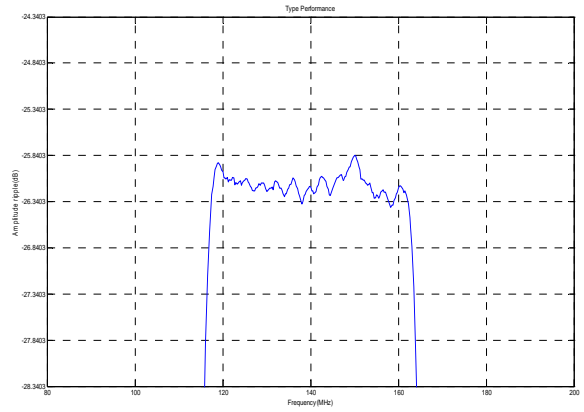

Horizontal: 20MHz/Div Vertical: 0.5dB/Div

Group Delay Variation(f0±23MHz)

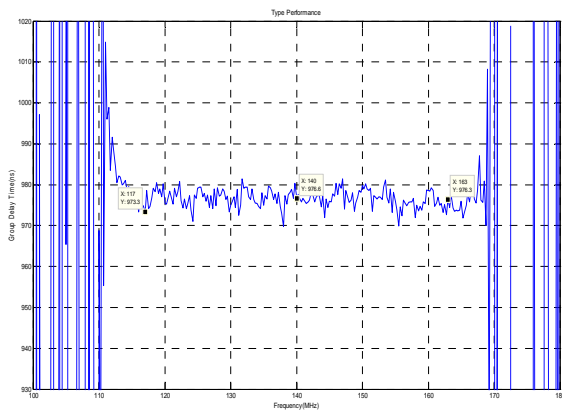

Horizontal: 10MHz/Div Vertical: 10ns/Div

Phase Linearity(f0±23MHz)

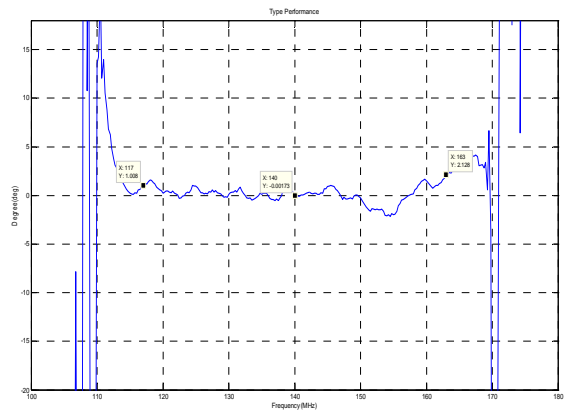

Horizontal: 10MHz/Div Vertical: 5deg/Div

Smith Chart S11

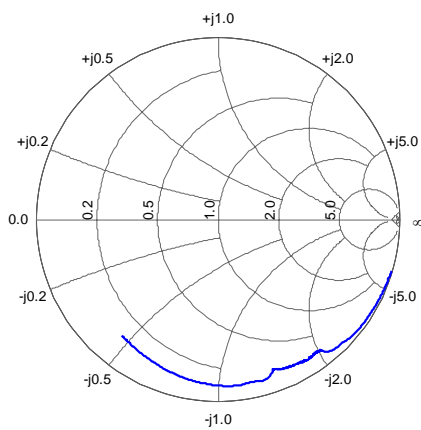

Smith Chart S22

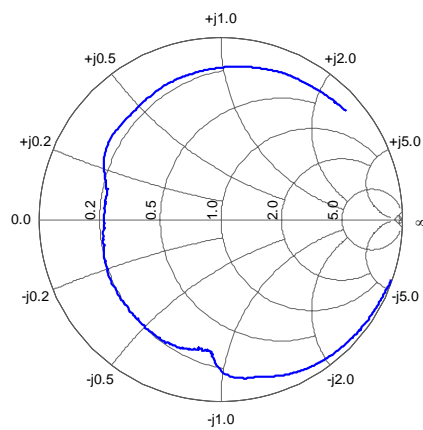

SIPAT Co., Ltd.
(CETC No.26 Research Institute)
#14 Nanping Huayuan Road,
Chongqing, China, 400060

Part Number	LBN14005	
Rev. Date	2008-12-24	
Ver.	1.1	Page 3/3